

■ MONITORS FOR FIREFIGHTING.



■ MORE POWER TO YOUR ELBOW: OPTIMIZED FLOW PATTERN, MAXIMUM REACH.

FireDos monitors are fit for firefighting with water or foam and deliver thousands of liters of water per minute, reaching 150 meters and more.

The innovative, flow-optimized 'Oval Flat Design' ensures minimum pressure loss, enabling maximum throw & reach for the monitors.

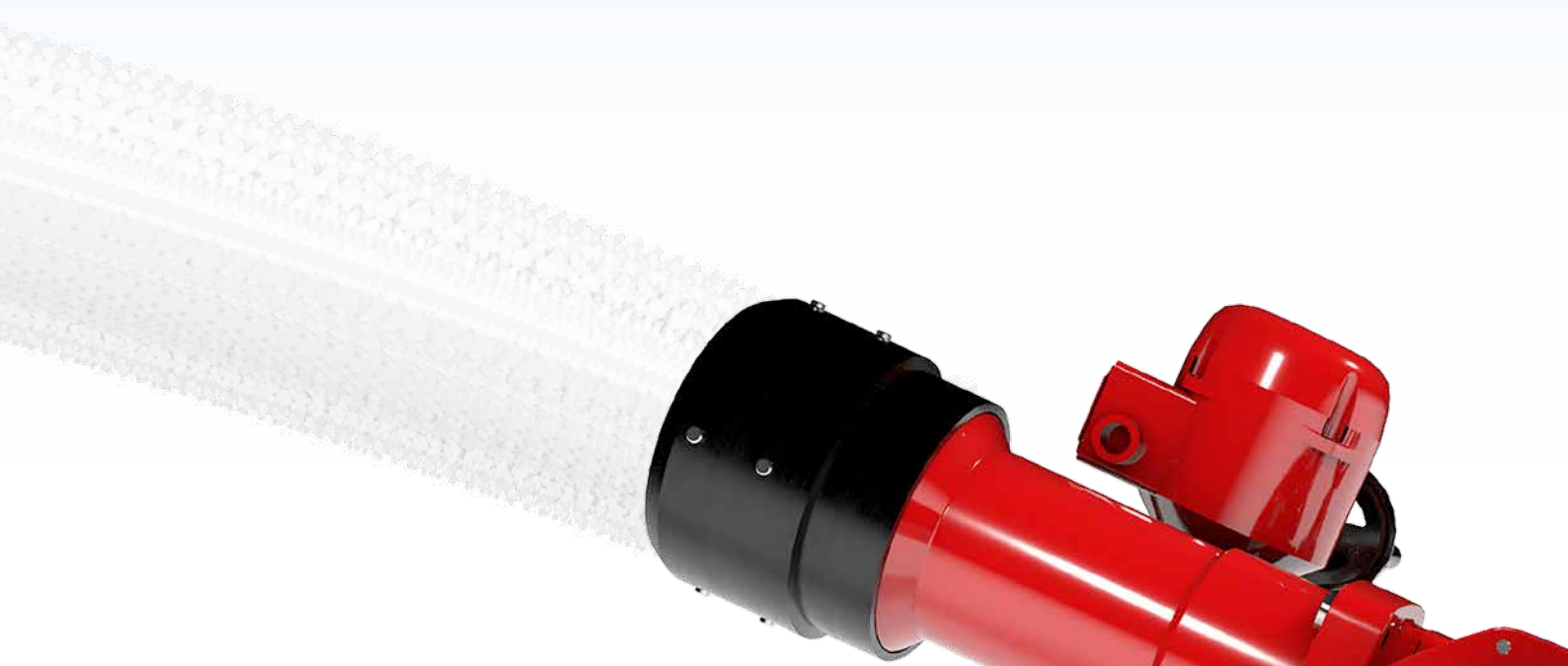

Standard shape:

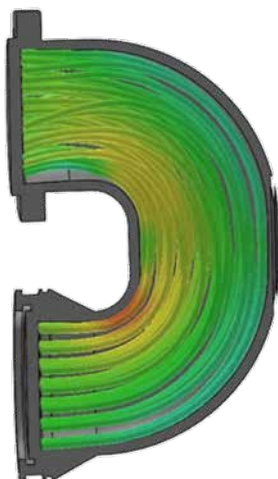

Oval Flat Design:

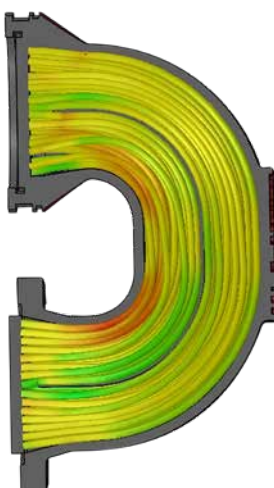

Low flow speed



High flow speed

- 1 Nozzle
- 2 Pivot mounting
- 3 Elbow in flow-optimized, octagonal 'Oval Flat Design'
- 4 Electrical drives
- 5 Hand wheels for emergency operation

The comparison is clear: The 'Oval Flat Design' significantly optimizes the flow leading to a more consistent flow pattern.

■ POWERFUL IN USE, CONVENIENT AND FLEXIBLE OPERATION.

■ FOR HIGH FLOW RATES, IN A COMPACT DESIGN.

FireDos monitors are designed to handle flow rates from 500 l/min to 60 000 l/min and controlled both manually and electrically. Depending on the type of application, various sizes are available – always with compact dimensions and a low design height.

■ FLEXIBILITY WHEN IT MATTERS.

Thanks to the design, operating the monitors requires minimal effort. Ensuring maximum flexibility when in use, the AMPN multi-purpose nozzle allows adjustment of the extinguishing agent flow rate during operation and full pressure.

The reach calculator on our webpage shows you the reach and height of the extinguishing agent jet as well as the resulting reaction force according to your individual input.

More information: firedos.com/monitors



INPUT PARAMETERS

MONITOR TYPE **M4**

Monitor with a maximum flow rate of up to 8000 l/min. Manual or electrical adjustment is possible.

NOZZLE TYPE **MPN**

Multi-purpose nozzle for discharge of water or low-expansion foam premix. Stepless adjustment between hollow jet and full jet is possible.

FLOW RATE **8000 l/min**

PRESSURE **10 bar**

ANGLE **30°**

MEDIUM **Water** / **Foam**

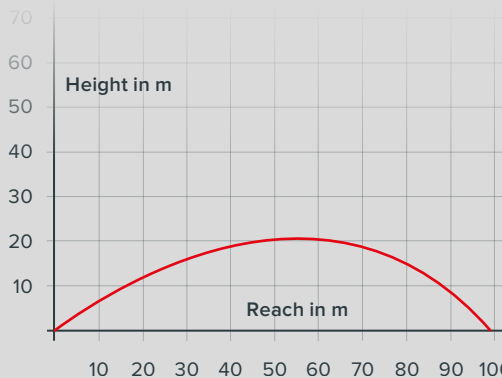

REACH **99 m**

REACTION FORCE **6 kN**

THROWING HEIGHT **20 m**

■ SECURITY FOR YOUR FIRE EXTINGUISHING SYSTEM

Powerful performance, long service life, convenient and flexible operation:
Play it safe with FireDos monitors.



A safe investment

Besides robust and reliable performance, FireDos monitors are sturdy and designed-to-last for all environmental conditions.



Easy operation and integration

The electrical control system is convenient to operate and facilitates easy integration into existing control systems, for error-free installation.



Flexible in use

FireDos monitors have a wide swiveling range and the extinguishing agent flow rate can be adjusted during operation.

■ WIDE SWIVELING RANGES.

Depending on the equipment version, the following maximum swiveling ranges are available:

- Horizontal (left/right): 360° (350° at DC drives)
- Vertical (up/down): +/-90°, depending on the selected version

Both swiveling axes (horizontal and vertical) have self-locking gears. No external force, occurring e.g. when opening the water flow or at varying flow rates, can adjust the monitor.

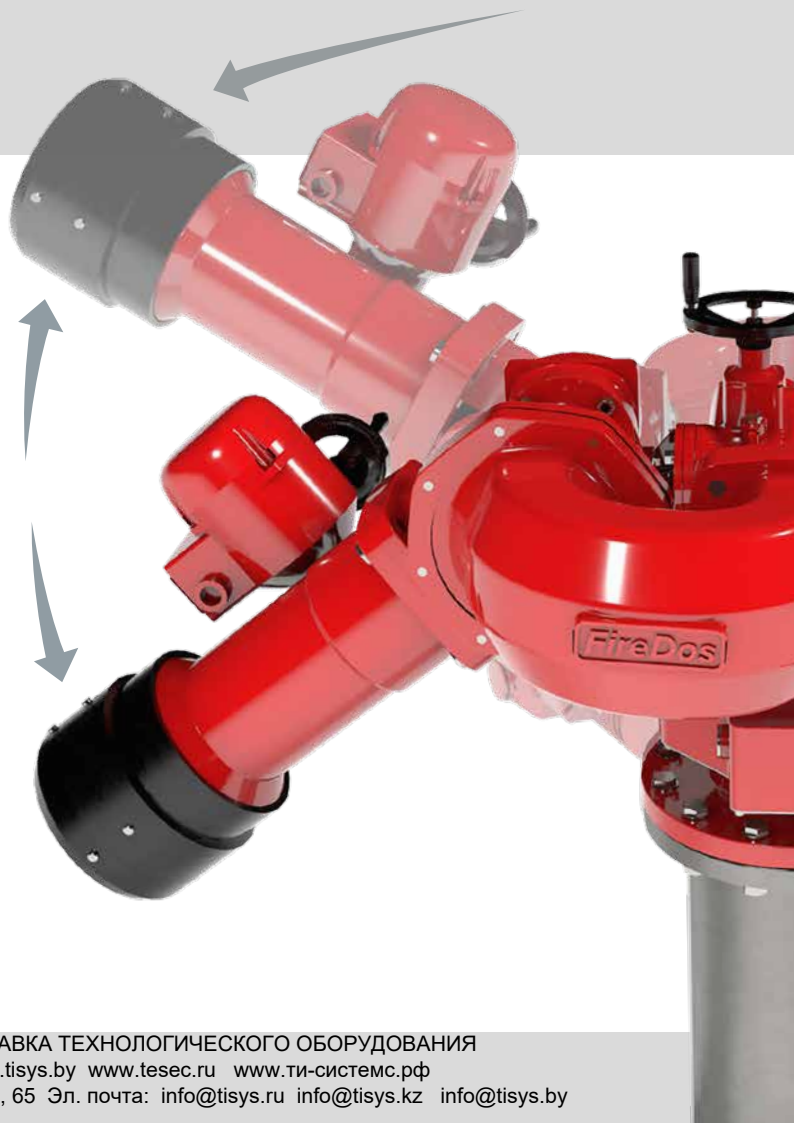

■ STURDY AND LONG-LASTING.

The media-exposed components are designed for working pressures up to 16 bar, with lubricated-for-life bearings. Reduced friction resistance seals guarantee ease of movement even after long down-times. The aluminium alloy castings are manufactured from marine grade, seawater-resistant aluminum alloy with an extra hard coating. ATEX versions for use in explosive areas are available.

■ ADJUSTABLE FLOW RATE

All type series are available with nozzles and foam pipes allowing flow rate adjustment even during operation and at full pressure.

AMPN Adjustable Multi-Purpose Nozzle

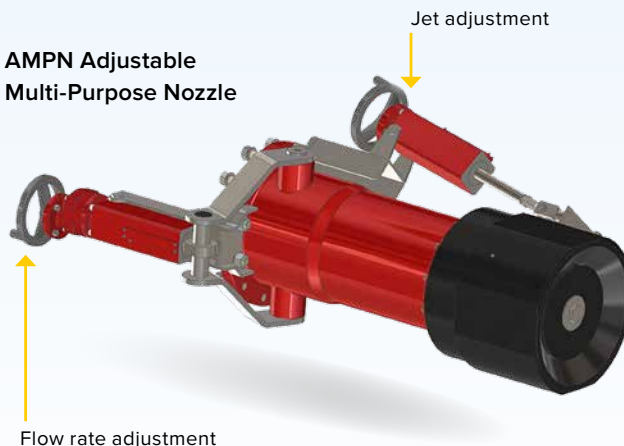

Flow rate adjustment

Jet adjustment

AMPN nozzle cross section

Small opening
> low water flow rate

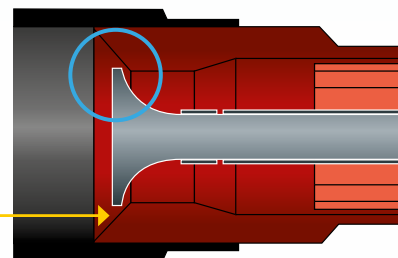

Large opening
> high water flow rate

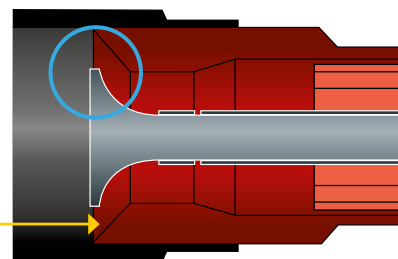

The monitors are available with manual or electrical controls.

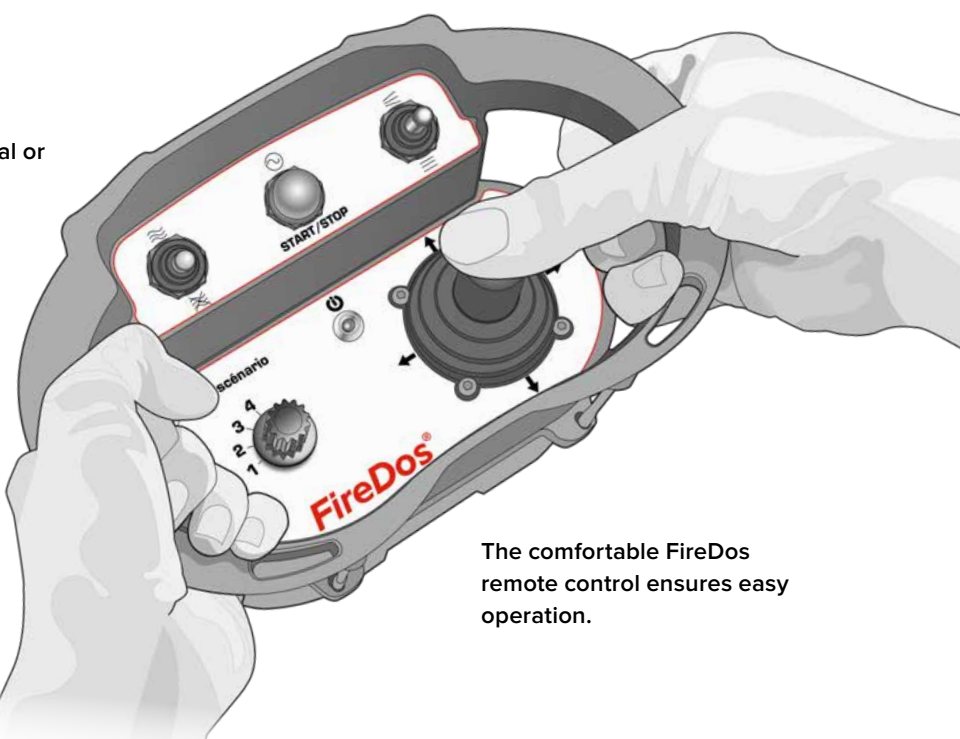

The comfortable FireDos remote control ensures easy operation.

■ OUR MONITORS IN ACTION.

FireDos monitors are used wherever extinguishing agents for fire class A and B are applied, outdoors and indoors. Typical fields of application include tank farms, waste incineration plants, jetties and aircraft hangars.



FIREDOS SERVICE: ALWAYS HERE FOR YOU!

We offer you comprehensive service – from planning to commissioning and maintenance. No matter which project phase you are in, we won't let you down. Our personnel is on site in no time, worldwide.

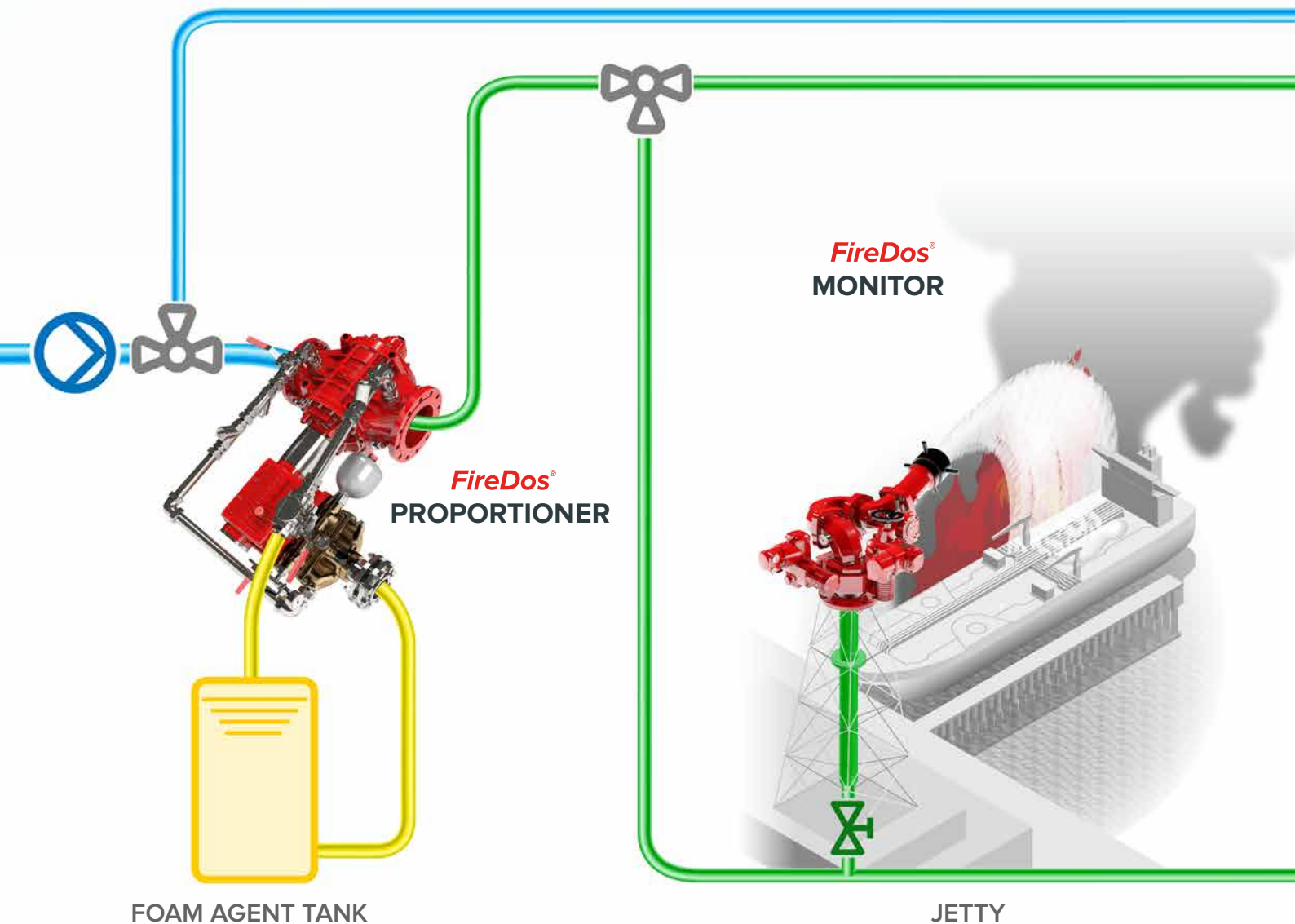

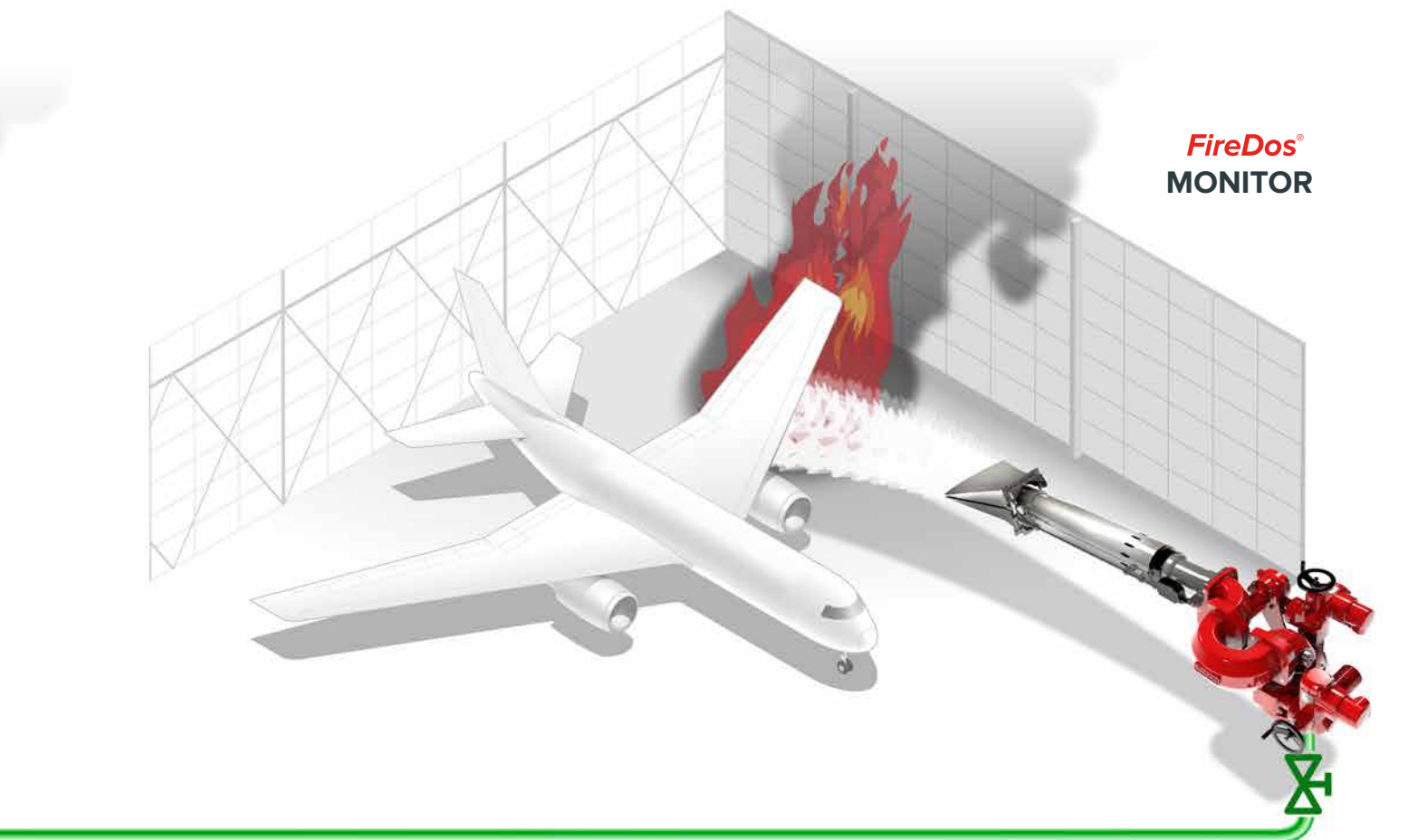
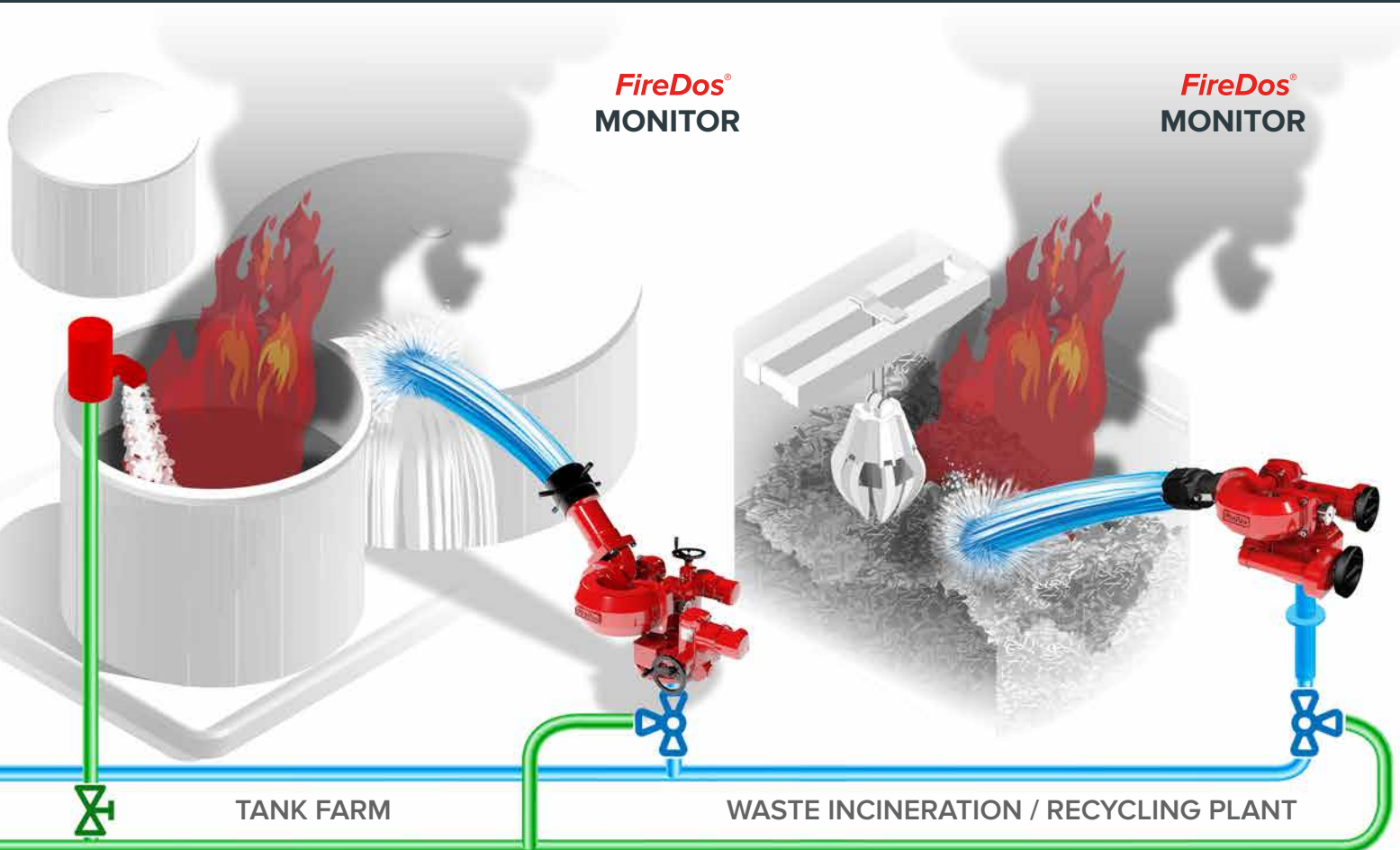

■ THE NOZZLE SHAPES THE JET.

The monitor's nozzle is of special importance when using monitors for firefighting as it is the nozzle that shapes the jet. No matter if water or foam, manual or electrical controls – we have the perfect nozzle for your monitor application.

■ MPN / AMPN MULTI-PURPOSE NOZZLES

The versatile multi-purpose nozzles allow discharge of water or low-expansion foam premix. In addition, stepless adjustment between hollow jet and spray jet is possible. Beyond the standard circle-shaped spray jet, a nozzle design is available for shaping a flat and wide spray jet.

Some fire scenarios require an adjustable extinguishing agent flow. The AMPN multi-purpose nozzle enables a change in the flow rate – during operation.

- Discharge of water or foam
- Hollow jet and spray jet with changing spraying angle.
- Adjustable extinguishing agent flow rate (25% to 100%)

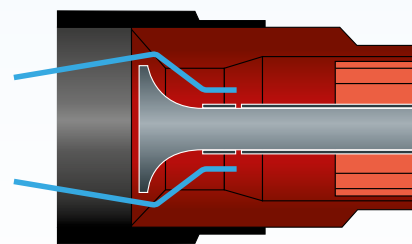

Hollow jet

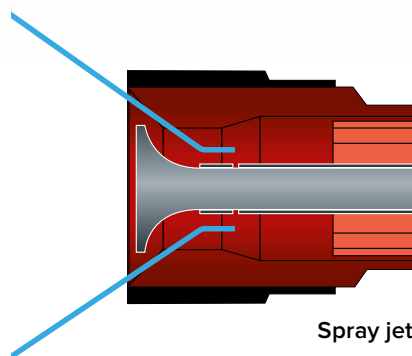

Spray jet



Flat jet with a modified spraying angle (special version)

■ RFP FOAM PIPE

The removable foam pipe can be applied as an addition to a multi-purpose nozzle. A typical field of application is the temporary discharge of low-expansion foam. Discharge of pure water is also possible.

- Addition to the multi-purpose nozzles MPN and AMPN
- Discharge of low-expansion foam or water



■ FPD / AFPD FOAM PIPE WITH DEFLECTOR

Foam pipes produce foam with a higher expansion rate. The FPD foam pipe is particularly suitable for the discharge of low-expansion foam. With the deflector in place, a wide jet can be produced for large-surface foam application.

As an option, the FPD foam pipe is available as a version for extinguishing agent flow rate adjustment (AFPD).

- Discharge of low-expansion foam
- Wide jet to produce a foam blanket
- Discharge of pure water is possible



Deflector open → full jet



Deflector closed → spray jet

■ JN FULL JET NOZZLE

Maximum reach required? The JN full jet nozzle produces a jet with a defined jet length and is suitable for the discharge of water.

- For maximum reach
- Discharge of water



NUMEROUS SIZES AND NOZZLES

■ MONITOR AND NOZZLE SELECTION

Depending on the requirements of your application, eight different monitor type series combined with various nozzle types are available.

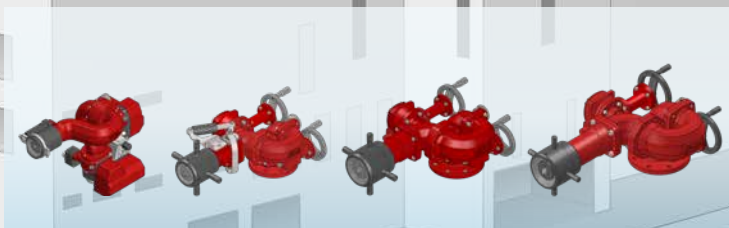

Type series

Max. extinguishing agent flow rate in l/min

M1

M2

M3

M4

2000

2500

4000

8000

Multi-purpose nozzle (MPN)



Multi-purpose nozzle with adjustable extinguishing agent flow rate (AMPN)



Removable foam pipe (RFP)



Foam pipe with deflector (FPD)



Foam pipe with deflector and adjustable extinguishing agent flow rate (AFPD)



Full jet nozzle (JN)



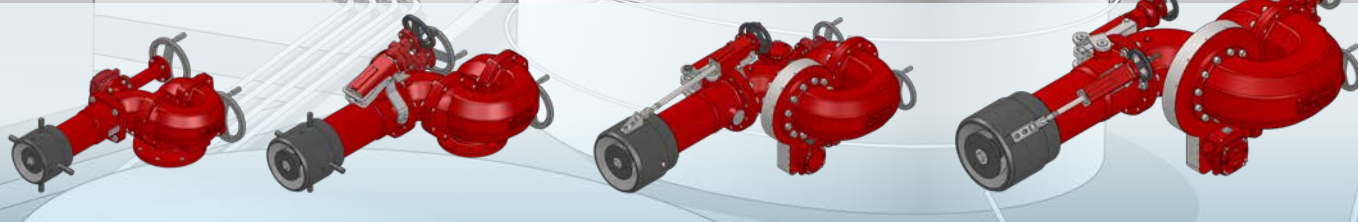
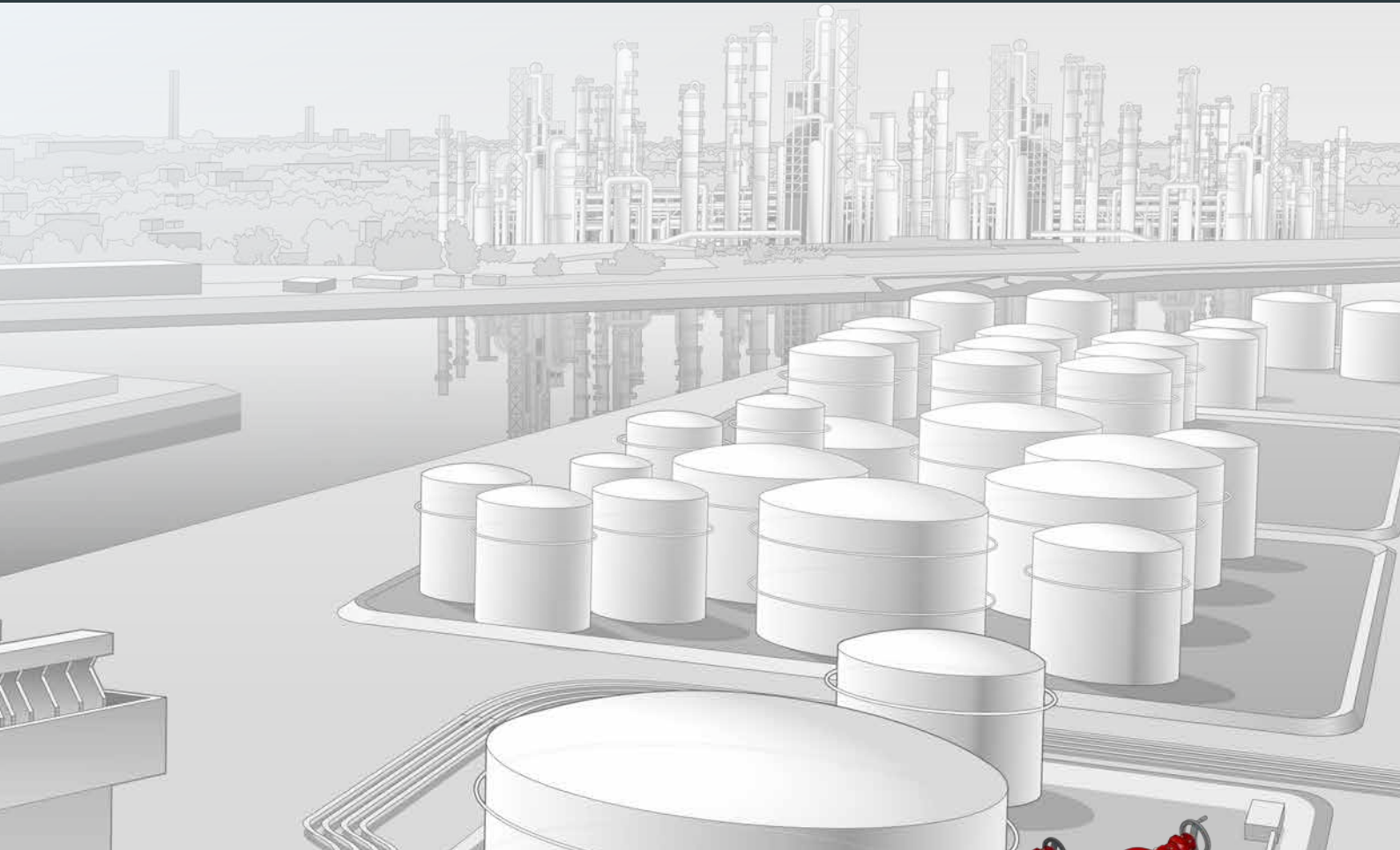

M5	M7	M9	M12
12000	24000	40000	60000
✓*	✓		
✓	✓	✓	✓
✓	✓	✓	✓
✓	✓		
✓	✓		
✓	✓	✓	✓



* Valid for selected product and drive types. See separate datasheet and FM Approval Guide entry.

■ A KEY ELEMENT OF THE AUTOMATED FIRE EXTINGUISHING SYSTEM.

For remote-controlled operation in stationary extinguishing systems, our monitors can be equipped with functional controls. Integration into existing thermal imaging systems is possible. Users benefit from minimum reaction times and maximum reliability.

■ FOR ALL TYPES OF ELECTRICAL DRIVES

We offer control systems for all types of electrical drives: Direct, alternating or three-phase current, regardless of voltage or frequency.

■ PORTABLE AND STATIONARY OPERATING PANELS

Controlled using mobile or permanently installed operating panels. Portable remote controls can also be implemented.

■ NUMEROUS CONTROL FUNCTIONS

Remote control of all monitor functions is possible - from traveling to park or working position, oscillating movement and automatic self-testing.

■ INDIVIDUAL INTEGRATION INTO EXISTING SYSTEMS

FireDos monitors process signals from early fire detection systems by various manufacturers. In addition, they support the signal exchange with superior control systems and fire alarm panels. Integration into CCTV monitoring solutions is also possible.



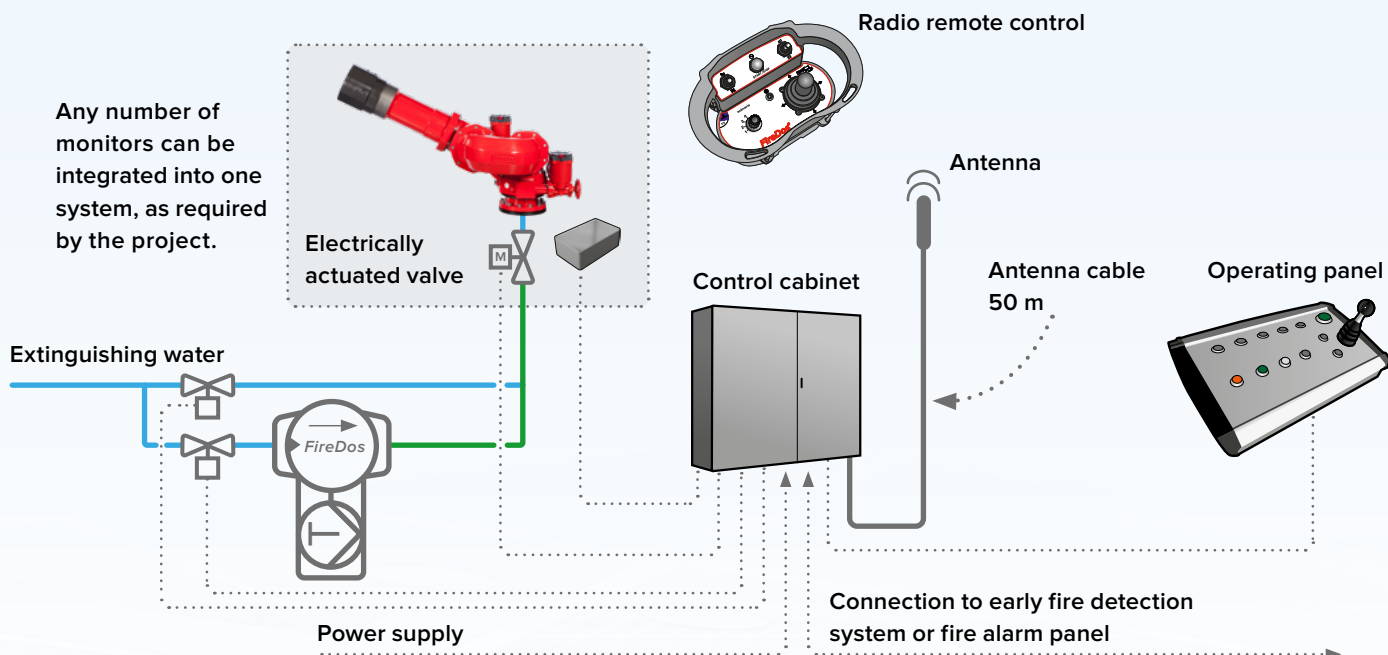

- Interfaces: Modbus TCP/IP, Modbus RTU, Ethernet/IP, Profibus, other interfaces upon request.
- Up-to-date operating elements (touch panels) with visualization
- Operating unit monitoring, sensor monitoring for wire breakage, short circuits and plausibility as well as functionality of the system by self-testing.
- Also Ex-protection available for use in zones 1, 2, 21 and 22.

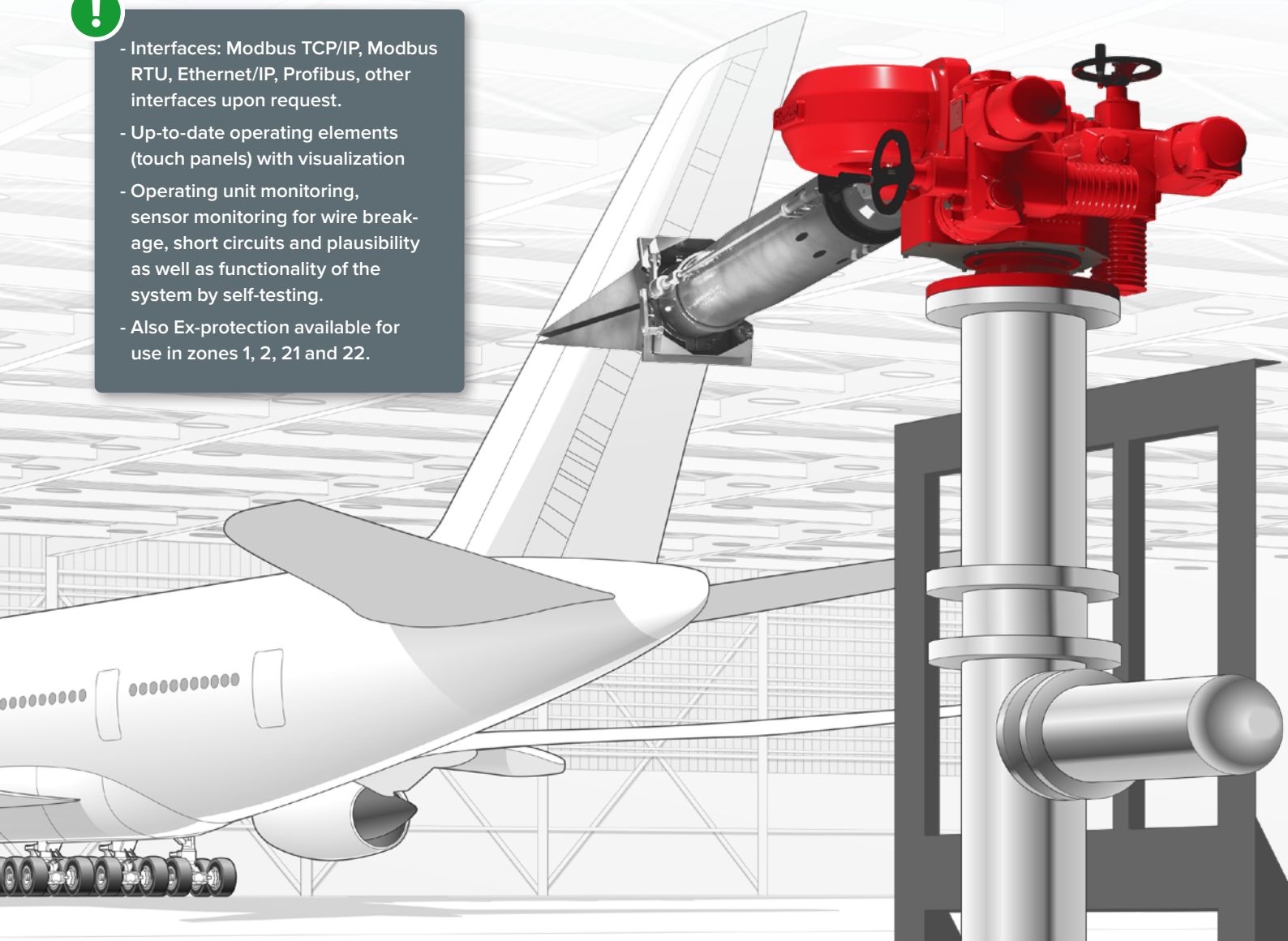



Monitor in a waste recycling plant, integrated in an infrared early fire detection system.

■ ELECTRICALLY ACTUATED DRIVES FOR DIRECT, ALTERNATING AND THREE-PHASE CURRENT

Direct, alternating or three-phase current: FireDos monitors are available with different drive types. The monitors are sturdy and fit for use in harsh environments. Their easy installation and low maintenance requirements save operators time and reduce costs.

Convenient: Integrated sensors allow easy swiveling range adjustment on-site. In case of a blackout, an optional UPS (uninterrupted power supply) guarantees continuous operation for the electrical controls on 24 VDC monitors. In all models, the monitor can be operated using handwheels.

■ THE ADVANTAGES OF ELECTRICALLY OPERATED MONITORS.



User-friendly

- Easy to install
- Little maintenance
- Integrated sensors for easy swiveling range adjustment on-site
- Handwheels for emergency operation. They can also be used when power supply is on



Sturdy

- Depending on the drive type, operating range from -40 °C to +80 °C as there are no restrictions regarding oil viscosity
- Suitable for harsh environments
- Protection class IP68 for versions with alternating or three-phase drives
- also available as ATEX version for zone 1 and 2



Eco-friendly

- no environmental pollution by oil loss
- reduced power demand due to little operating forces

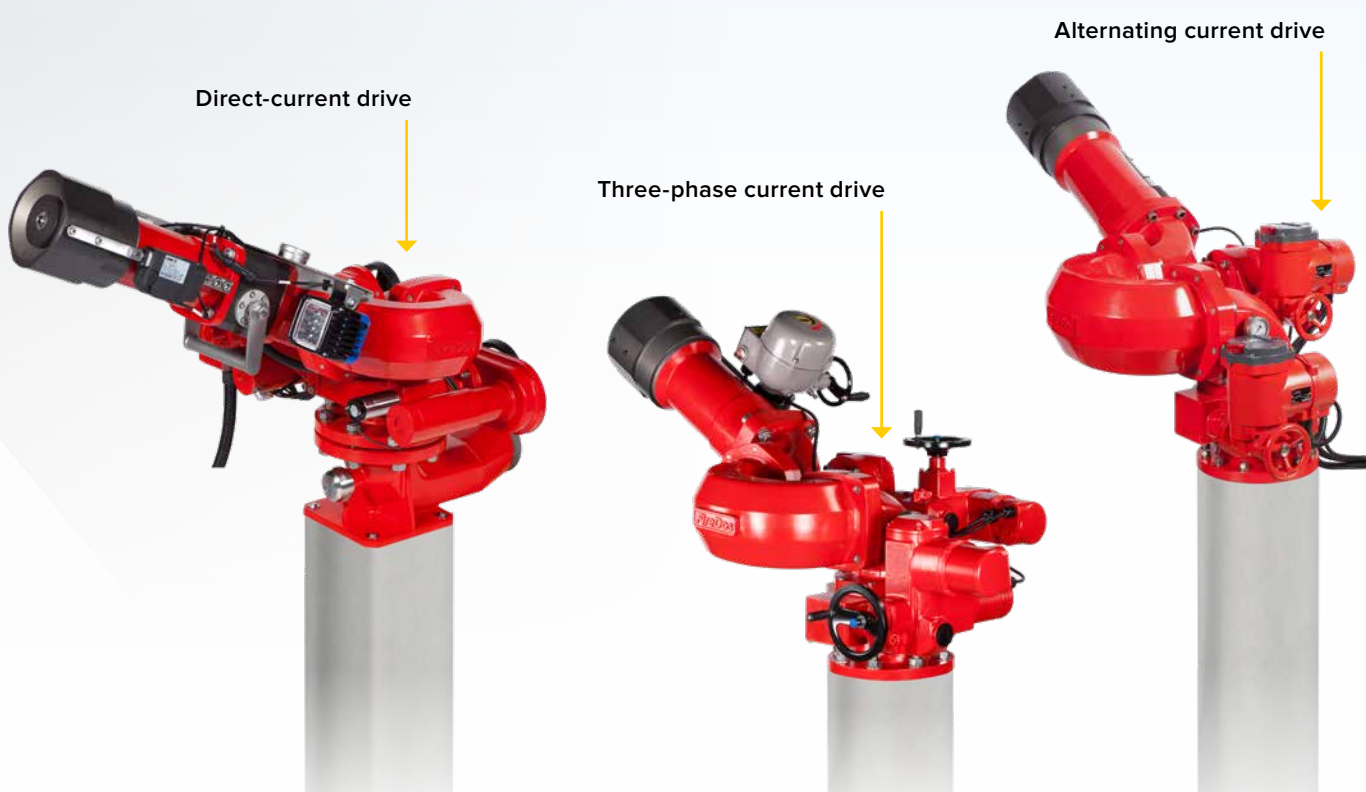



■ OUR SERVICE PROMISE – YOUR ALLROUND CAREFREE PACKAGE.

FireDos assist during planning, commissioning and maintenance of your monitor, worldwide. No matter what type of monitor, at heights or unusual places – no distance is too far and no application too sophisticated. Contact us. We will be pleased to help.

Further brochures:

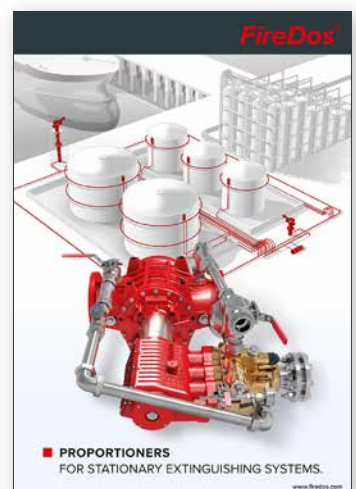

PRPE-037-EN-06